

- Brackets for convenient positioning on square shafts.
- Push the push button to unlock the lock and release the push button to fix it in position.
- Operating principle
CUSB-2B internal rollers push on and secure the square shaft to the attachment surface.
 If using **CUSB-2B** without fixing to a device/machine, use the bottom cover **CUSB-BC** (sold separately). → P.xxxx

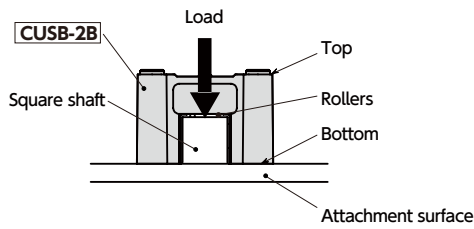

- Can retain up to 100 N.
- Push button press count resistance is 10,000 times (reference value).

Material/Finish RoHS

	CUSB-2B
Bracket Body	Zinc Die Cast Chrome Plating (Matte)
Push Button	Polyacetal (Orange)

Unit : mm

Part Number	W	L1	L	H	Applicable Square Shaft	Max. Retention Force*1 (N)	Mass (g)
CUSB-2B-1212	12	12	25.5	4	□12 _{-0.43}	100	149
CUSB-2B-1616	16	16	29.5	8	□16 _{-0.43}	100	160

*1: Static load retaining **CUSB-2B** and the square shaft.

• CUSB-BC Bottom Cover

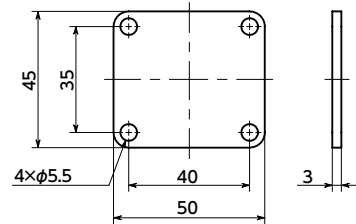

Material/Finish RoHS

	CUSB-BC
Main Body	SUS304
Special Low Profile Cap Screws SSH-M5-10-EL	SCM435 Electroless Nickel Plating

Part Number	Mass (g)
CUSB-BC	57

- 4 special low profile cap screws **SSH-M5-10-EL** for installing to **CUSB-2B** are included.

- Usage example
 Limit switches attached to **CUSB-2B** can be fixed at any desired location parallel to the secured square shaft.

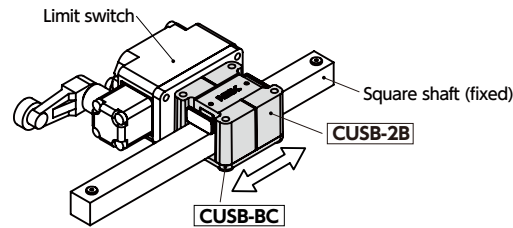

- Proximity sensors attached to the square shaft can be fixed at any desired location.

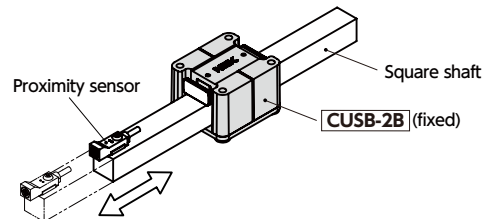

• Usage

- Mount **CUSB-2B** to the device/machine attachment surface or the bottom cover and secure to **CUSB-BC** with 4 bolts.
 A load of 500N will be generated at the attachment surface if maximum retention force (100N) is applied. Design the attachment surface to withstand these loads.
 When fixing from **CUSB-2B** top When fixing from **CUSB-2B** bottom

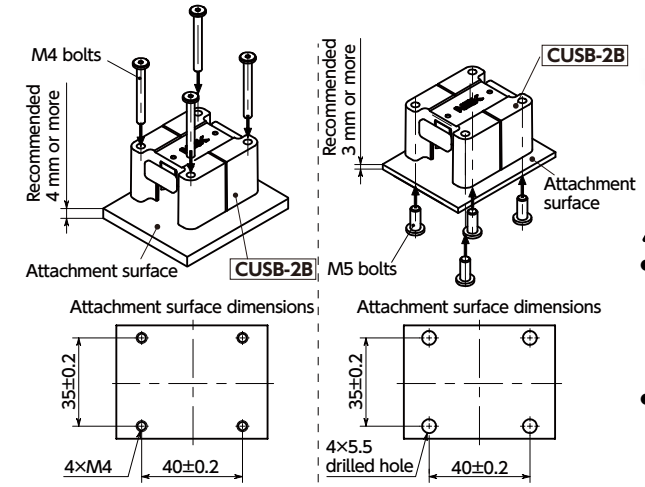

- Push the button on **CUSB-2B** to release the lock and mount **CUSB-2B** onto the square shaft.

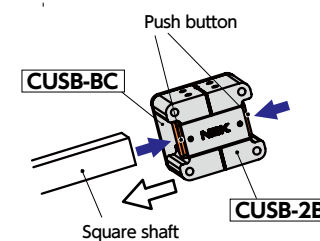

- While continuing to push the button, move **CUSB-2B** to the location it should be fixed.

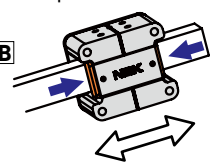

- Release the push button to operate the lock mechanism, securing **CUSB-2B** to the square shaft.

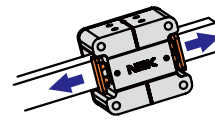

- Pushing the button again releases the lock, enabling **CUSB-2B** or the square shaft to be moved to the desired position.

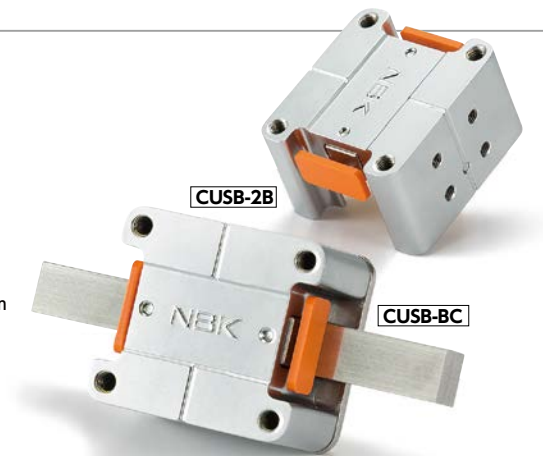
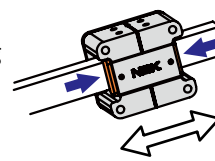

⚠ Precautions for Use

- Use **CUSB-2B** while fixed to a device/machine or bottom cover **CUSB-BC**. The square shaft will not be retained if using without installing to a device/machine or bottom cover.
- Insert the square shaft after securing **CUSB-2B** to a device/machine or bottom cover. If the square shaft is inserted first, **CUSB-2B** may be damaged.
- If only one side of the push button is pressed after locking, the lock in the direction the push button is pressed will release.
- **CUSB-2B** is a product that uses friction fastening. In cases where oil, etc. adhered to the square shaft causes the friction coefficient to decrease or if impact loads or vibrations occur, the maximum retention force may decrease.
- The surface may be scratched depending on the material and surface finish of the square shaft.
- If excessive loads are applied, then the square shaft may be scratched or **CUSB-2B** may be damaged.
- If excessive loads are applied and the push button is locked, operate the push button after loosening the bolts securing **CUSB-2B**. **CUSB-2B** may be damaged if operation is forced.

- Part number specification

CUSB-2B-1212

